

Designed for measuring small measuring strain ranges as required for proof load testing of bolts and similar applications such as yield measurement.

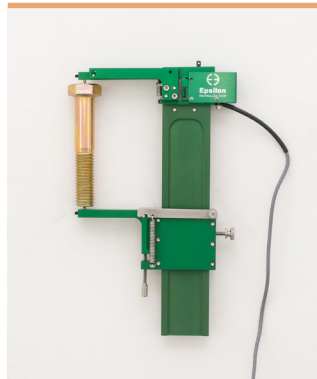

Model 3565 extensometer for bolt proof load testing

The Model 3565 uses hard conical points to contact the bolt at the center of the head and at the bottom. It is fully adjustable for different length bolts ranging from 25 mm (1 inch) in length to 150 mm (6 inches) standard. Extension beams are available for longer bolts. The standard maximum measuring range is 1.25 mm (0.05 inches). Generally, on longer bolts this extensometer will be self-supported without requiring any centering marks or punch marks on the bolt. For shorter bolts these marks may be required. If the conical pins are sharp, marks are often not needed even on the shortest bolts.

The extensometer has a zero adjustment screw to adjust the length between the contact pins. This is used to set the output voltage to zero, which corresponds to the correct starting position for the test. It also includes a breakaway lower arm. In the event a bolt should fail, the breakaway arm snaps free, helping to prevent damage to the extensometer. This is easily re-installed. In the event that bolt failures are likely during a test, it is recommended the user attach a cord around the upper part of the beam and tie the other end to the test frame to prevent the extensometer from falling. The conical point contacts included with the extensometer are made from tungsten carbide.

The Model 3565 extensometers are strain gaged devices, making them compatible with any electronics designed for strain gaged transducers. Most often they are connected to a test machine controller. The signal conditioning electronics for the extensometer is typically included with the test machine controller or may often be added. In this case the extensometer is shipped with the proper connector and wiring to plug directly into the electronics. For systems lacking the required electronics, Epsilon can provide a variety of solutions, allowing the extensometer output to be connected to data acquisition boards, chart recorders or other equipment.

See the electronics section of this catalog for available signal conditioners and strain meters.

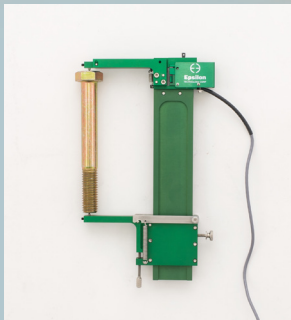

Gauge length may be set to any length by sliding, locking, and fine-adjusting the lower arm

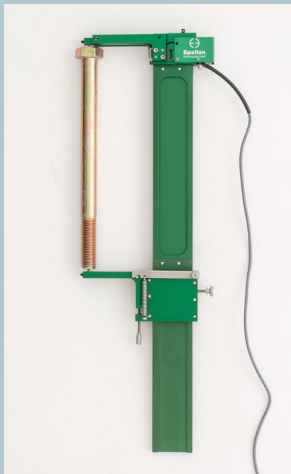

Gauge length adapters may be added for longer fasteners.

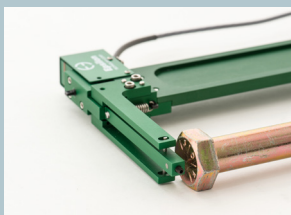

Mechanical overtravel protection for the upper arm and a break-away lower arm protect the extensometer if the bolt fails

Features

- Full bridge, 350 ohm strain gaged design for compatibility with nearly any test system.
- All standard units have linearity readings of 0.20% or better.
- Rugged, dual flexure design for improved performance.
- Includes high quality foam lined case.
- Breakaway arm to help prevent extensometer damage in the event of bolt failure.
- Self-supporting on the bolt specimen typically without the need for centering or punch marks.

SPECIFICATIONS

- Excitation:** 5 to 10 VDC recommended, 12 VDC or VAC max.
Output: 2 to 4 mV/V, nominal, depending on model
Linearity: $\leq 0.20\%$ of full scale measuring range, depending on model
Temperature Range: Standard (-ST) is $-40\text{ }^{\circ}\text{C}$ to $+100\text{ }^{\circ}\text{C}$ ($-40\text{ }^{\circ}\text{F}$ to $210\text{ }^{\circ}\text{F}$)
 Optional (-LHT) is $-270\text{ }^{\circ}\text{C}$ to $+200\text{ }^{\circ}\text{C}$ ($-454\text{ }^{\circ}\text{F}$ to $400\text{ }^{\circ}\text{F}$)
Cable: Integral, ultra-flexible cable, 2.5 m (8 ft) standard
Throat Depth: Model 3565: up to 56.4 mm (2.22 inches)
 Model 3565E: up to 97.8 mm (3.85 inches)

OPTIONS

- Connectors to interface to nearly any brand test equipment
- Gauge length extension adapters
- Shunt calibration module (see page 120)

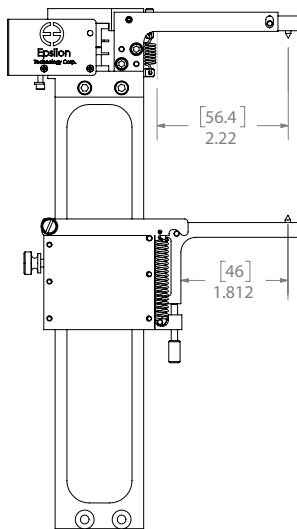

Model 3565

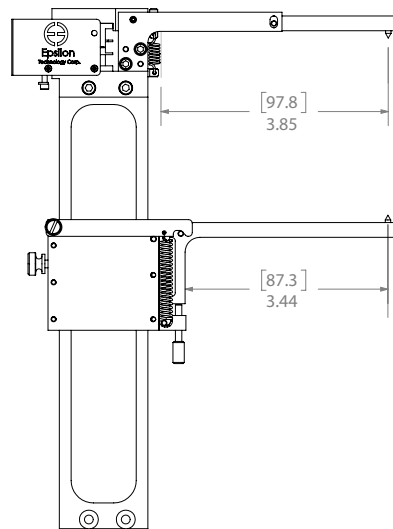

Model 3565E

ORDERING INFORMATION

Model 3475 Available Versions: ANY combination of measuring range and temperature range listed below is available. *Other configurations may be available with special order; please contact Epsilon to discuss your requirements.*

Measuring Range	
METRIC	
-125M	+1.25 mm
U.S.A.	
-050T	+0.050"

Model Number 3565- _____ - _____
Model Number 3565E- _____ - _____

Model 3565: throat depth up to 56.4 mm (2.22 inches)
Model 3565E: throat depth up to 97.8 mm (3.85 inches)

Temperature Range	
-LT	$-270\text{ }^{\circ}\text{C}$ to $100\text{ }^{\circ}\text{C}$ ($-454\text{ }^{\circ}\text{F}$ to $210\text{ }^{\circ}\text{F}$)
-ST	$-40\text{ }^{\circ}\text{C}$ to $100\text{ }^{\circ}\text{C}$ ($-40\text{ }^{\circ}\text{F}$ to $210\text{ }^{\circ}\text{F}$)
-HT1	$-40\text{ }^{\circ}\text{C}$ to $150\text{ }^{\circ}\text{C}$ ($-40\text{ }^{\circ}\text{F}$ to $300\text{ }^{\circ}\text{F}$)
-HT2	$-40\text{ }^{\circ}\text{C}$ to $200\text{ }^{\circ}\text{C}$ ($-40\text{ }^{\circ}\text{F}$ to $400\text{ }^{\circ}\text{F}$)
-LHT	$-270\text{ }^{\circ}\text{C}$ to $200\text{ }^{\circ}\text{C}$ ($-454\text{ }^{\circ}\text{F}$ to $400\text{ }^{\circ}\text{F}$)

Example: 3565-125M-HT2: +1.25 mm measuring range, high temperature option ($-40\text{ }^{\circ}\text{C}$ to $200\text{ }^{\circ}\text{C}$)

Visit our website at www.epsilontech.com
 Contact us for your special testing requirements.

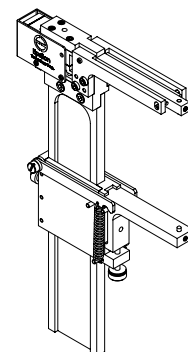

MODEL 3565 EXAMPLE